



---

## Inverter

Inverter i510-Cabinet

0.25 ... 15 kW

As easy as that.

## Hardware overview of the inverter

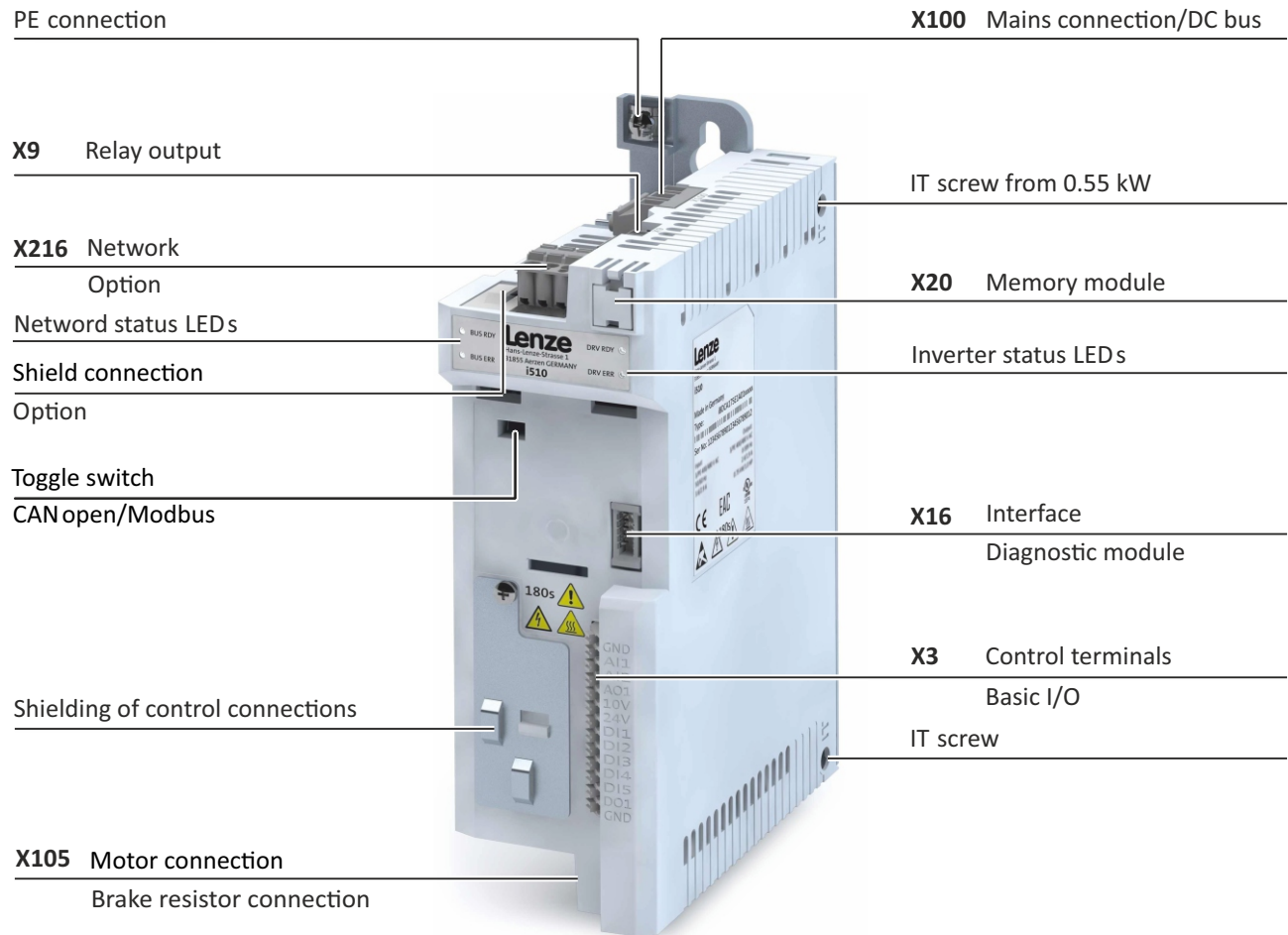

Contents

<b>1</b>	<b>General information.....</b>	<b>4</b>	<b>7</b>	<b>Commissioning.....</b>	<b>15</b>
1.1	Target group .....	4	7.1	Keypad module .....	15
1.2	Application as directed .....	4	7.1.1	Functions of the keys .....	16
1.3	Device-specific standards and directives.....	4	7.1.2	Example of the keypad handling.....	16
1.4	Relevant standards and directives for the operator.....	4	7.1.3	Quick commissioning- terminal control .....	16
1.5	Identification of the products .....	5	7.1.4	Extended terminal control .....	17
<b>2</b>	<b>Safety instructions .....</b>	<b>5</b>	7.2	Keypad control .....	17
2.1	Basic safety measures .....	5	7.3	Commissioning with the EASY Starter .....	17
2.2	Layout of warning notices.....	6	7.4	The most important parameters at a glance.....	18
2.3	Residual hazards .....	6	7.4.1	Group 0: Favorites.....	18
<b>3</b>	<b>Technical data .....</b>	<b>7</b>	7.4.2	Group 2: Basic setting .....	22
3.1	Standards and operating conditions.....	7	7.4.3	Group 3: Motor control .....	22
3.2	Connection to the IT system .....	7	7.4.4	Group 7: Additional functions.....	23
<b>4</b>	<b>Mechanical installation .....</b>	<b>8</b>	<b>8</b>	<b>Troubleshooting.....</b>	<b>24</b>
4.1	Dimensions and assembly .....	8	8.1	Error message .....	24
<b>5</b>	<b>Electrical installation .....</b>	<b>9</b>	8.2	Reset error .....	24
5.1	General overview of the connections .....	9	8.3	Error codes .....	25
5.2	EMC-compliant installation.....	9	8.4	LED status.....	27
5.3	Control terminals .....	10	<b>9</b>	<b>Further documents .....</b>	<b>27</b>
5.4	Relay output.....	10	<b>10</b>	<b>Disposal .....</b>	<b>27</b>
5.5	Single-phase mains connection 230/240 V .....	11	<b>11</b>	<b>Glossary .....</b>	<b>27</b>
5.6	Three-phase mains connection 230/240 V .....	12			
5.7	Three-phase mains connection 400 V .....	13			
5.8	Three-phase mains connection 480 V .....	14			
<b>6</b>	<b>Initial switch-on .....</b>	<b>15</b>			

### 1 General information

Please read this documentation carefully before installing the inverter and observe the safety instructions!

This document only includes the most frequently asked questions and presents them in a simplified form for a better overview. Detailed technical and functional explanations can be found in the comprehensive product documentation.

The complete documentation, further information and tools regarding Lenze products can be found on the Internet: <http://www.Lenze.com>

#### 1.1 Target group

Work on the product must only be carried out by qualified personnel. Specialist personnel must be qualified in accordance with IEC 60364 or CENELEC HD 384. Qualified personnel are persons who have the following knowledge and experience:

- They are familiar with the installation, mounting, commissioning, and operation of electrical and electronic modules.
- They have the corresponding qualifications for their work.
- They know and can apply all regulations for the prevention of accidents, directives, and laws applicable at the place of use.

#### 1.2 Application as directed

The product is designed for the installation into electrical systems or machinery.

The i500 product family is designed for the power range of 0.25 ... 15 kW. The inverter i510 is suitable for conveyor and travelling drives, pumps, fans, winders, lifting systems and many other machine tasks. The inverter is not to be used as a household appliance, but for commercial or professional purposes only.

The inverter is not a machine in terms of the Machinery Directive.

#### 1.3 Device-specific standards and directives

- The product meets the protection requirements of the Low-Voltage Directive 2014/35/EU.
- The harmonized standard EN 61800-5-1 is used for the inverters.

#### 1.4 Relevant standards and directives for the operator

##### Application as directed

- If the product is used in accordance with the technical data, the drive systems comply with the EN 61800-3 categories.
- The inverter may only be used commercially or professionally as defined by EN 61000-3-2.
- The test voltage for insulation resistance tests between a control potential of 24 V and PE must be measured in accordance with EN 61800-5-1.
- The cables must be installed in accordance with EN 60204-1 or US National Electrical Code NFPA 70 / Canadian Electrical Code C22.1.

##### Commissioning

- Commissioning or starting the operation as directed of a machine with the product is prohibited until it has been ensured that the machine meets the regulations of the Machinery Directive (2006/42/EC) and the standard EN 60204-1.
- Commissioning or starting the operation as directed is only permissible if the EMC Directive 2014/30/EU is complied with.

## 1.5 Identification of the products

		I	5	1	A	E	xxx	x	1	x	x	x	x	xxxx
Product type	Inverter	I												
Product family	i500		5											
Product	i510			1										
Product generation	Generation 1				A									
	Generation 2				B									
Mounting type	Control cabinet mounting					E								
Rated power [W] (examples)	0.25 kW						125							
	0.55 kW						155							
	2.2 kW						222							
Mains voltage and connection type	1/N/PE AC 230/240 V							B						
	1/N/PE AC 230/240 V							D						
	3/N/PE AC 230/240 V													
	3/PE AC 230/240 V							C						
	3/PE AC 400 V 3/PE AC 480 V							F						
Motor connections	Single axis							1						
Integrated functional safety	Without								0					
Degree of protection	IP20									0				
	IP20, coated									V				
Interference suppression	Without										0			
	Integrated RFI filter										1			
Design types	Global type 50 Hz											0		
	Local type 60 Hz											1		
	Basic I/O without network												000S	
	Basic I/O with CANopen/Modbus													001S

## 2 Safety instructions

### 2.1 Basic safety measures

Disregarding the following basic safety measures may lead to severe personal injury and damage to property!

- The product:
  - must only be used as directed.
  - must never be commissioned if they display signs of damage.
  - must never be technically modified.
  - must never be commissioned if they are not fully mounted.
  - must never be operated without required covers.
  - must only be disconnected from the installation in de-energized condition.
- Connect/disconnect all pluggable terminals only in de-energized condition.
- Carry out insulation resistance tests between 24-V control potential terminals and PE. The maximum test voltage must not exceed 110 V DC.

The safety measures are the condition for safe and trouble-free operation and the achievement of the specified product features.

The procedural notes and circuit details given in this document are suggestions and their transferability to the respective application has to be checked. The manufacturer does not take responsibility for the suitability of the process and circuit proposals.

The product may cause EMC interferences. The operator is responsible for executing the interference suppression measures.

### 2.2 Layout of warning notices

Safety instructions protect against injury to persons or damage to property. The measures described for the prevention of hazards must be complied with.



#### DANGER

Indicates an extremely hazardous situation. Failure to comply with this instruction will result in severe irreparable injury and even death.



#### WARNING

Indicates an extremely hazardous situation. Failure to comply with this instruction may result in severe irreparable injury and even death.



#### CAUTION

Indicates a hazardous situation. Failure to comply with this instruction may result in slight to medium injury.

#### NOTE

Indicates a material hazard. Failure to comply with this instruction may result in material damage.





### 2.3 Residual hazards

The user must take the residual hazards mentioned into consideration in the risk assessment for his/her machine/system.

If the above is disregarded, this may result in injuries to persons and material damage!

#### Product

Observe the warning labels on the product!

Icon	Description
	<b>Electrostatic charges</b> Before working on the product, the staff must ensure they are free of any electrostatic charges.
	<b>Electrical voltage</b> Before working on the product, check that all power connections are de-energized! After the mains power has been disconnected, the power connections carry considerable hazardous electrical voltage for the time stated on the product!
	<b>High leakage current</b> Implement fixed installation and PE connection!
	<b>Hot surface</b> Use personal protective equipment or wait until the device has cooled down!

#### Motor

In the event of a short circuit of two power transistors, a residual movement of up to 180°/ number of pole pairs on the motor may occur (e.g. 4-pole motor): residual movement max.  $180^\circ / 2 = 90^\circ$ .

### 3 Technical data

#### 3.1 Standards and operating conditions

<b>Conformities</b>	CE	2014/35/EU, 2014/30/EU
	EAC	TR TC 004/2011, TP TC 020/2011
	RoHS 2	2011/65/EU
<b>Approvals</b>	cUL <sub>us</sub>	UL 61800-5-1, CSA 22.2 No. 274
<b>Energy efficiency</b>	Class IE2	EN 50598-2
<b>Protection type</b>	IP20	EN 60529 (except in wire range of terminals)
		NEMA 250 (type 1 protection against accidental contact only)
	Open type	Only in UL-approved systems
<b>Power systems</b>	TT, TN	Voltage against earth: max. 300 V
	IT	Apply the measures described for IT systems!
<b>Mains switching</b>		3 x within one minute possible
<b>Operation with earth-leakage circuit breaker (optional) (120-V mains and 230-V mains)</b>		Up to 4 kW 30 mA, above this 300 mA
<b>Operation with earth-leakage circuit breaker (optional) (400-V mains)</b>		Up to 4 kW 30 mA, above this 300 mA
<b>Cable length for EMC</b>	Category C2	Max. 20 m ( $\leq 0.37$ kW max. 15 m)
	Category C3	Max. 35 m ( $\leq 0.37$ kW max. 15 m)
<b>Switching frequencies</b>		2, 4, 8, 16 kHz. The rated output currents apply at 45 °C and switching frequencies of 2 and 4 kHz, and at 40 °C and switching frequencies of 8 and 16 kHz
<b>Ambient temperature</b>		55 °C (derating of 2.5 %/ °C above 45 °C)
<b>Max. Output frequency</b>		0 Hz ... 599 Hz
<b>Overload capacity (120-V mains and 230-V mains)</b>		200 % for 3s; 150 % for 60 s
<b>Overload capacity (400-V mains)</b>		200 % for 3 s; Heavy Duty: 150 % for 60 s; Light Duty: 125 % for 60 s

#### 3.2 Connection to the IT system

##### NOTE

##### Electrical voltage

Internal components have ground potential if the IT screws are not removed.

The monitoring devices of the IT system will be triggered.

► Before connection to an IT system be absolutely sure to remove the IT screws.



## 4 Mechanical installation

### 4.1 Dimensions and assembly

	Rated power [kW]	Weight [kg]	H [mm]	W [mm]	D [mm]	H1 [mm]	X [screws + hole spacing]	E1 [mm]	E2 [mm]
<b>1-phase mains connection 230/240 V; with integrated RFI filter</b>									
I51AExxxB	0.25 ... 0.37	0.75	155	60	130	165	1 - - M5	50	50
I51AExxxB	0.55 ... 0.75	0.95	180	60	130	190	1 - - M5	50	50
I51AExxxB	1.1 ... 2.2	1.35	250	60	130	260	1 - - M5	50	50
<b>1-/3-phase mains connection 230/240 V; without integrated RFI filter</b>									
I51AExxxD	0.25 ... 0.37	0.75	155	60	130	165	1 - - M5	50	50
I51AExxxD	0.55 ... 0.75	0.95	180	60	130	190	1 - - M5	50	50
I51AExxxD	1.1 ... 2.2	1.35	250	60	130	260	1 - - M5	50	50
I51AExxxC	4.0 ... 5.5	2.1	250	90	130	260	2 30 M5	50	100
<b>Three-phase mains connection 400 V/480 V ... Heavy duty; with integrated RFI filter</b>									
I51AExxxF	0.37	0.75	155	60	130	165	1 - - M5	50	50
I51AExxxF	0.55 ... 0.75	0.95	180	60	130	190	1 - - M5	50	50
I51AExxxF	1.1 ... 2.2	1.35	250	60	130	260	1 - - M5	50	50
I51BExxxF	3.0 ... 4.0	1.35	250	60	130	260	1 - - M5	50	50
I51AExxxF	3.0 ... 5.5	2.3	250	90	130	260	2 30 M5	50	100
I51AExxxF	7.5 ... 11.0	3.7	276	120	130	285	2 60 M5	50	100
<b>Three-phase mains connection 400 V/480 V ... Light duty; with integrated RFI filter</b>									
I51AExxxF	4.0 ... 7.5	2.3	250	90	130	260	2 30 M5	50	100
I51AExxxF	11.0 ... 15.0	3.7	276	120	130	285	2 60 M5	50	100

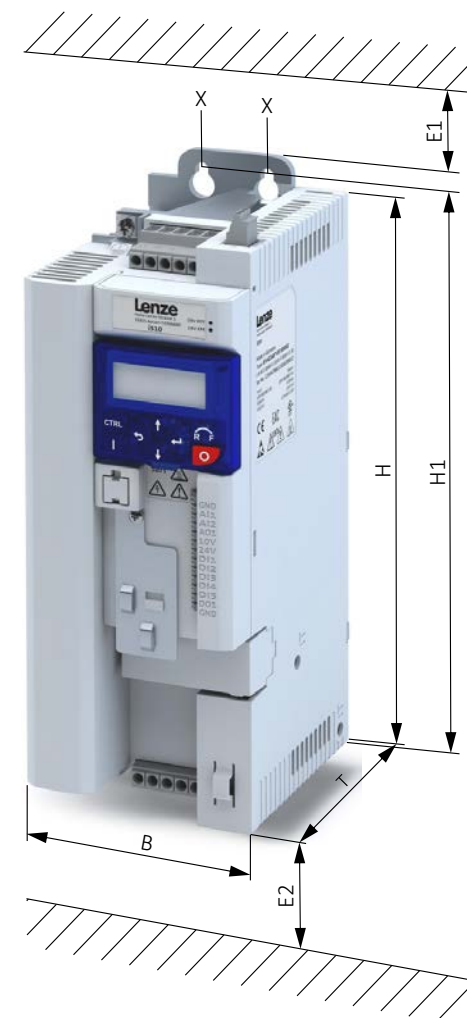

- H: Device height
- B: Device width
- T: Device depth
- H1: Hole dimension for top/bottom fixing
- X: Number of top/bottom fixings (lower fastening not visible)
- X ... X: Hole spacing over center of device
- E1: Top mounting clearance
- E2: Bottom mounting clearance



## 5 Electrical installation

### 5.1 General overview of the connections

The connection diagram is considered exemplary for all voltage and power classes. Deviating mains connection diagrams can be found in the corresponding chapters.

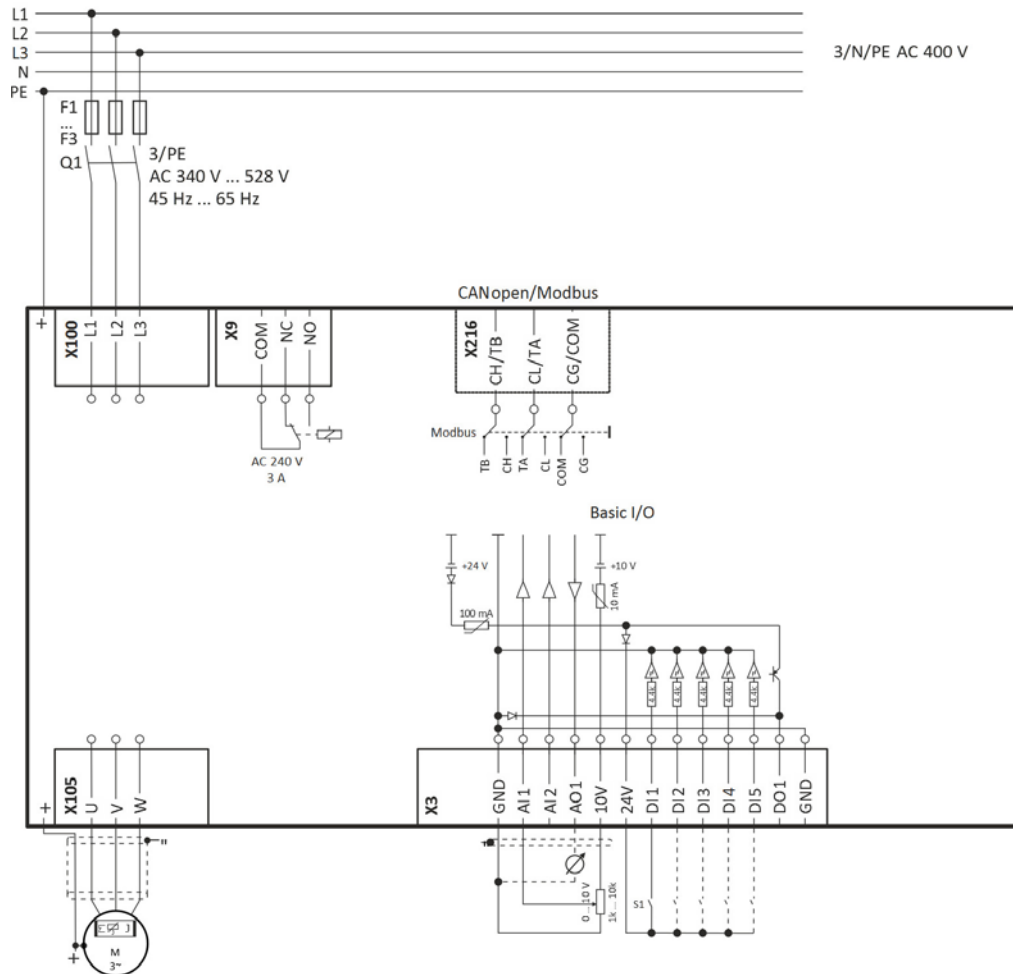

### 5.2 EMC-compliant installation

The drive system (inverter and drive) complies with the EMC Directive 2014/30/EU if it is installed according to the guidelines for CE-typical drive systems.

The structure in the control cabinet must support the EMC-compliant installation with shielded motor cables.

- Please use sufficiently conductive shield connections.
- Connect the housing with shielding effect to the grounded mounting plate with a surface as large as possible, e. g. of inverters and RFI filters.
- Use central earthing points.

The following figure shows an example of effective wiring with shielding on the control cabinet wall.

- A Shielding of control connections
- B Control cable
- C Electrically conductive mounting plate
- D Shield clamps
- E Low-capacitance motor cable  
(C-core/core/C-core/shield <math>< 75/150 \text{ pF/m} \leq 2.5 \text{ mm}^2</math>;  
C-core/core/C-core/shield <math>< 150/300 \text{ pF/m} \geq 4 \text{ mm}^2</math>)

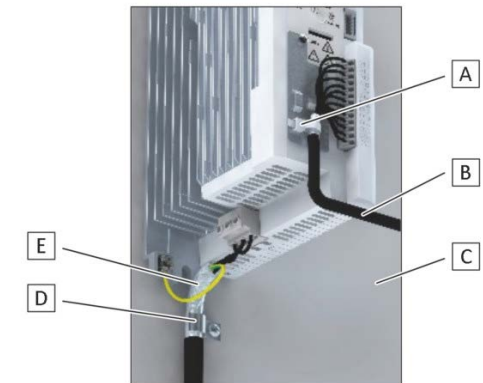

Alternatively, the motor cable can be shielded on an optional motor shield plate.

## 5.3 Control terminals

### Basic I/O

Input/output	Terminal X3	Information
Digital inputs	DI1, DI2, DI3, DI4, DI5	DI3/DI4 can be optionally used as frequency or encoder input. HIGH active/LOW active switchable LOW = 0 ... +3 V, HIGH = +12 V ... +30 V
Digital outputs	DO1	Digital output (max. 100 mA)
Analog inputs	AI1, AI2	Can be optionally used as voltage input or current input.
Analog outputs	AO1	Can be optionally used as voltage output or current output.
10-V output	10 V	Primarily for the supply of a potentiometer (1 ... 10 kΩ). Max. 10 mA
24-V output	24 V	Primarily for the supply of digital inputs. (Max. 100 mA)
Reference potential	GND	
Connection system	Plug-in spring terminal	

Inverter	[kW]	0.25 ... 15
Connection		Control terminals X3
Connection type		Spring terminal
Max. cable cross-section	mm <sup>2</sup>	1.5
Stripping length	mm	9
Tightening torque	Nm	-
Tools required		0.4 x 2.5

### Control terminals

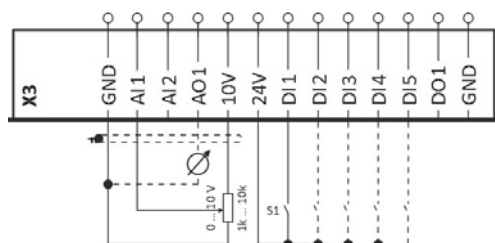

## 5.4 Relay output

The relay is not suitable for direct switching of an electromechanical holding brake. Use a corresponding suppressor circuit in case of an inductive or capacitive load.

Inverter	[kW]	0.25 ... 15
Connection		Relay output X9
Connection type		Pluggable screw terminal
Max. cable cross-section	mm <sup>2</sup>	1.5
Stripping length	mm	6
Tightening torque	Nm	0.2
Tools required		0.4 x 2.5
Max. switching voltage/switching current	COM	Common contact
	NC	Normally-closed contact
	NO	Normally-open contact
		AC 240 V/3 A
		DC 24 V/2 A
		DC 240 V/0.16 A

### Relay output

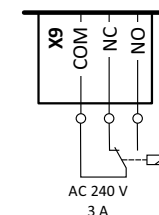

## 5.5 Single-phase mains connection 230/240 V

### Terminal data, 1-phase 230/240 V

Inverter	[kW]	I51AExxxB	I51AExxxD	I51AExxxB	I51AExxxD	I51AExxxx	I51AExxxB	I51AExxxD
		0.25 ... 0.75		1.1 ... 2.2		0.25 ... 2.2	0.25 ... 2.2	
Connection		Mains connection X100				PE connection	Motor connection X105	
Connection type		Pluggable screw terminal				PE screw	Pluggable screw terminal	
Max. cable cross-section	mm <sup>2</sup>	2.5		6		6	2.5	
Stripping length	mm	8		8		10	8	
Tightening torque	Nm	0.5		0.7		2	0.5	
Tools required		0.5 x 3.0		0.6 x 3.5		Torx 20	0.5 x 3.0	

### Fusing data/performance data

Inverter	[kW]	0.25	0.37	0.55	0.75	1.1	1.5	2.2
Rated output current	A	1.7	2.4	3.2	4.2	6	7	9.6
Max. output current (15s)	A	2.6	3.6	4.8	6.3	9	10.5	14.4
Operation without mains choke								
Fuse		gG/gL or gRL						
Characteristic								
Max. rated current	A	10	10	16	16	25	25	25
Circuit breaker		B						
Characteristic								
Max. rated current	A	10	10	16	16	25	25	25
Earth-leakage circuit breaker								
1-phase mains connection		≥ 30 mA, type B						

### Mains connection

Valid for I51AExxxD inverter.

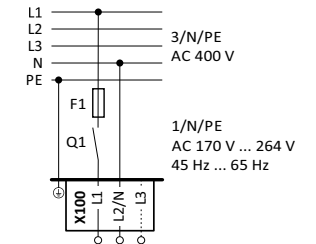

Valid for I51AExxxD inverter.

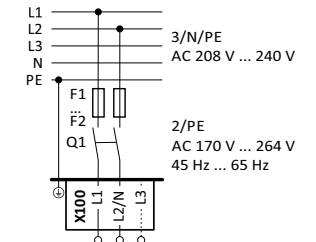

Valid for I51AExxxB inverter.

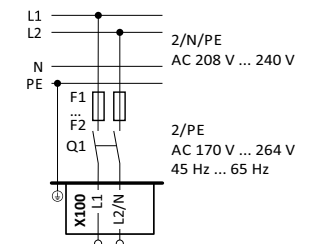

### Motor connection

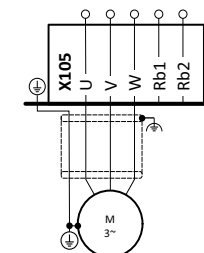

### 5.6 Three-phase mains connection 230/240 V

#### Terminal data, 3-phase 230/240 V

Inverter	[kW]	I51AExxxD	I51AExxxD	I51AExxxC	I51AExxxx	I51AExxxD	I51AxxxC
		0.25 ... 0.75	1.1 ... 2.2	4 ... 5.5	0.25 ... 5.5	0.25 ... 2.2	4 ... 5.5
Connection		Mains connection X100			PE connection	Motor connection X105	
Connection type		Pluggable screw terminal		Screw terminal	PE screw	Pluggable screw terminal	Screw terminal
Max. cable cross-section	mm <sup>2</sup>	2.5	6	6	6	2.5	6
Stripping length	mm	8	8	9	10	8	9
Tightening torque	Nm	0.5	0.7	0.5	2	0.5	0.5
Tools required		0.5 x 3.0	0.6 x 3.5		Torx 20	0.5 x 3.0	0.6 x 3.5

#### Fusing data/performance data

Inverter	[kW]	0.25	0.37	0.55	0.75	1.1	1.5	2.2	4	5.5	7.5
Rated output current (heavy duty)	A	1.7	2.4	3.2	4.2	6	7	9.6	16.5	23	-
Max. output current (15s)	A	2.6	3.6	4.8	6.3	9	10.5	14.4	24.8	34.5	-
Rated output current (light duty)	A	-	-	-	-	-	-	-	-	20.6	27.6
Max. output current (15s)	A	-	-	-	-	-	-	-	-	33	46
<b>Operation without mains choke</b>											
Fuse		gG/gL or gRL									
Characteristic		gG/gL or gRL									
Max. rated current	A	10	10	16	16	25	25	25	32	32	-
Circuit breaker		B									
Characteristic		B									
Max. rated current	A	10	10	16	16	25	25	25	32	32	-
<b>Operation with mains choke</b>											
Fuse		gG/gL or gRL									
Characteristic		gG/gL or gRL									
Max. rated current	A	10	10	16	16	25	25	25	32	32	32
Circuit breaker		B									
Characteristic		B									
Max. rated current	A	10	10	16	16	25	25	25	32	32	32
Earth-leakage circuit breaker		≥ 30 mA, type B									
3-phase mains connection		≥ 30 mA, type B									≥ 300 mA, type B

#### Mains connection

Valid for I51AExxxC inverter.

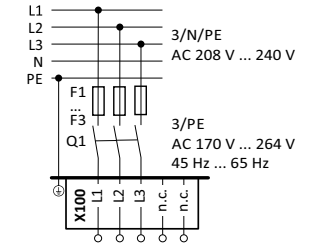

Valid for I51AExxxD inverter.

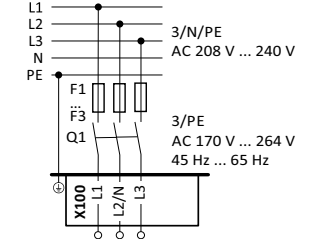

#### Motor connection

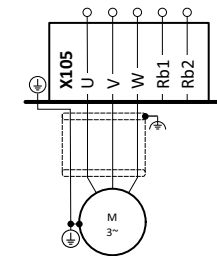

## 5.7 Three-phase mains connection 400 V

### Terminal data, 3-phase 400 V

		I51AExxxF	I51BExxxF	I51AExxxF	I51AExxxF	I51AExxxF	I51AExxxF	I51AxxxF	I51AxxxF	I51AxxxF
<b>Inverter</b>	<b>[kW]</b>	<b>0.37 ... 2.2</b>	<b>3 ... 4</b>	<b>3 ... 5.5</b>	<b>7.5 ... 11</b>	<b>0.37 ... 5.5</b>	<b>7.5 ... 11</b>	<b>0.37 ... 2.2</b>	<b>3 ... 5.5</b>	<b>7.5 ... 11</b>
Connection		Mains connection X100				PE connection		Motor connection X105		
Connection type		Pluggable screw terminal	Pluggable screw terminal	Screw terminal		PE screw		Pluggable screw terminal	Screw terminal	
Min. cable cross-section	mm <sup>2</sup>	1				1.5		1		
Max. cable cross-section	mm <sup>2</sup>	2.5	2.5	6	16	6	16	2.5	6	16
Stripping length	mm	8	8	9	11	10	11	8	9	11
Tightening torque	Nm	0.5	0.5	0.5	1.2	2	3.4	0.5	0.5	1.2
Tools required		0.5 x 3.0	0.5 x 3.0	0.6 x 3.5	0.8 x 4.0	Torx 20	PZ2	0.5 x 3.0	0.6 x 3.5	0.8 x 4.0

### Fusing data/performance data

<b>Inverter</b>	<b>[kW]</b>	<b>0.37</b>	<b>0.55</b>	<b>0.75</b>	<b>1.1</b>	<b>1.5</b>	<b>2.2</b>	<b>3</b>	<b>4</b>	<b>5.5</b>	<b>7.5</b>	<b>11</b>	<b>15</b>
Rated output current (heavy duty)	A	1.3	1.8	2.4	3.2	3.9	5.6	7.3	9.5	13	16.5	23.3	-
Max. Output current (15 s)	A	2.6	3.6	4.8	6.4	7.8	11.2	14.6	19	26	33	47	-
Rated output current (light duty)	A	-	-	-	-	-	-	-	8.8	11.9	15.6	23	28.2
Max. Output current (15 s)	A								14.6	19	26	33	47
<b>Operation without mains choke</b>													
Fuse													
Characteristic		gG/gL or gRL											-
Max. rated current	A	10	10	10	16	16	16	25	25	25	32	32	-
Circuit breaker													
Characteristic		B											-
Max. rated current	A	10	10	10	16	16	16	25	25	25	32	32	-
<b>Operation with mains choke</b>													
Fuse													
Characteristic		gG/gL or gRL											-
Max. rated current	A	10	10	10	16	16	16	25	25	25	32	32	32
Circuit breaker													
Characteristic		B											-
Max. rated current	A	10	10	10	16	16	16	25	25	25	32	32	32
Earth-leakage circuit breaker													
3-phase mains connection		≥ 30 mA, type B						≥ 300 mA, type B					

A mains choke must be used for light duty loads over 15 kW.

### Mains connection

Valid for I51AExxxF inverter.

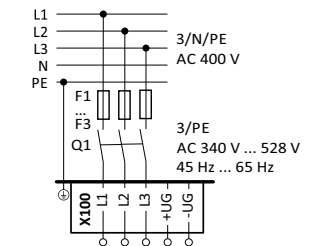

### Motor connection

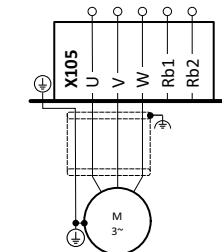

## 5.8 Three-phase mains connection 480 V

### Terminal data, 3-phase 480 V

		I51AExxxF	I51AExxxF	I51AExxxF	I51AExxxF	I51AExxxF	I51AxxxF	I51AxxxF	I51AxxxF
Inverter	[kW]	0.37 ... 2.2	3 ... 5.5	7.5 ... 11	0.37 ... 5.5	7.5 ... 11	0.37 ... 2.2	3 ... 5.5	7.5 ... 11
Connection		Mains connection X100			PE connection		Motor connection X105		
Connection type		Pluggable screw terminal	Screw terminal		PE screw		Pluggable screw terminal	Screw terminal	
Min. cable cross-section	mm <sup>2</sup>	1			1.5		1		
Max. cable cross-section	mm <sup>2</sup>	2.5	6	16	6	16	2.5	6	16
Stripping length	mm	8	9	11	10	11	8	9	11
Tightening torque	Nm	0.5	0.5	1.2	2	3.4	0.5	0.5	1.2
Tools required		0.5 x 3.0	0.6 x 3.5	0.8 x 4.0	Torx 20		0.5 x 3.0	0.6 x 3.5	0.8 x 4.0

### Fusing data/performance data

Inverter	[kW]	0.37	0.55	0.75	1.1	1.5	2.2	3	4	5.5	7.5	11	15
Rated output current (heavy duty)	A	1.1	1.6	2.1	3	3.5	4.8	6.3	8.2	11	14	21	-
Max. Output current (15 s)	A	2.2	3.2	4.2	6	7	9.6	12.6	16.4	22	28	42	-
Rated output current (light duty)	A	-	-	-	-	-	-	-	7.6	9.8	13.2	18.3	25.2
Max. Output current (15 s)	A	-	-	-	-	-	-	-	12.6	16.4	22	28	42
<b>Operation without mains choke</b>													
Fuse													
Characteristic		gG/gL or gRL											-
Max. rated current	A	10	10	10	16	16	16	25	25	25	32	32	-
Circuit breaker													
Characteristic		B											-
Max. rated current	A	10	10	10	16	16	16	25	25	25	32	32	-
<b>Operation with mains choke</b>													
Fuse													
Characteristic		gG/gL or gRL											-
Max. rated current	A	10	10	10	16	16	16	25	25	25	32	32	32
Circuit breaker													
Characteristic		B											-
Max. rated current	A	10	10	10	16	16	16	25	25	25	32	32	32
Earth-leakage circuit breaker													
3-phase mains connection		≥ 30 mA, type B					≥ 300 mA, type B						

A mains choke must be used for light duty loads over 15 kW.

### Mains connection

Valid for I51AExxxF inverter.

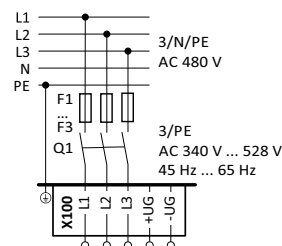

### Motor connection

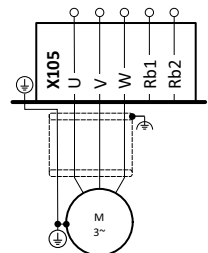

## 6 Initial switch-on



**DANGER**

### Electrical voltage

Incorrect wiring can cause unexpected states during the commissioning phase.

- ▶ Wiring must be complete and correct.
- ▶ Check the wiring to ensure that it is free of short circuits and earth faults.
- ▶ Adapt the motor circuit configuration (star/delta) to the inverter.
- ▶ Connect the motor in the correct phase relation (rotating direction).
- ▶ Check the “Emergency off” function of the overall system.
- ▶ Clear the hazard area.
- ▶ Observe safety instructions and safety clearances.

### Conditions

- The power connections must be wired.
- The digital inputs X3/DI1 (start/stop), X3/DI3 (reversal of rotation direction) and X3/DI4 (frequency preset 20 Hz) must be wired.
- The analog input X3/AI1 must not be wired or connected to GND.

### Switch on mains voltage

- ▶ Switch on mains voltage and check readiness for operation.

Observe LED status displays “RDY” and “ERR” on the inverter front panel.

See “LED status”.  27

## 7 Commissioning



**DANGER**

### Electrical voltage

Incorrect wiring can cause unexpected states during the commissioning phase.

- ▶ Wiring must be complete and correct.
- ▶ Check the wiring to ensure that it is free of short circuits and earth faults.
- ▶ Adapt the motor circuit configuration (star/delta) to the inverter.
- ▶ Connect the motor in the correct phase relation (rotating direction).
- ▶ Check the “Emergency off” function of the overall system.
- ▶ Clear the hazard area.
- ▶ Observe safety instructions and safety clearances.









### 7.1 Keypad module

- ▶ Plug the keypad onto the inverter.

The keypad can also be connected and removed during operation.



## 7.1.1 Functions of the keys

Key	Actuation	Action
	Press briefly	<ul style="list-style-type: none"> <li>Navigate in the Menu Change parameters</li> </ul>
	Press briefly	<ul style="list-style-type: none"> <li>Go to Menu/Parameters Confirm parameters</li> </ul>
	Press and hold for 3s	<ul style="list-style-type: none"> <li>Save parameters</li> <li>"P.SAVED" in the display indicates that the parameters have been saved</li> </ul>
	Press briefly	Quit Menu/Parameters
	Press briefly	Activate keypad control
	Press briefly	Start motor
	Press briefly	Change rotating direction
	Press briefly	Stop motor

The motor must be at standstill before parameters can be changed or confirmed.

The settings are saved temporarily until the motor is switched off again. Press  and hold the key for 3 s to save the settings permanently.

## 7.1.2 Example of the keypad handling

Example for DO1 function assignment with parameter P420.02.

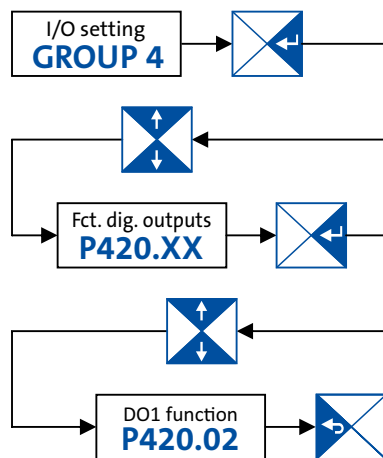

## 7.1.3 Quick commissioning ... terminal control

The following quick overview with graphical parameter representation is sufficient for commissioning many applications with terminal control. Further setting options are described in this document or in the commissioning document.

- Load default setting = set **P700.01** to 1.
- Set the following parameters for V/f characteristic control:
  - Mains voltage **P208.01**
  - V/f characteristic data: Base voltage **P303.01**
  - V/f characteristic data: Base frequency **P303.02**
  - Minimum frequency **P210.00**
  - Maximum frequency **P211.00**
  - Acceleration time 1 **P220.00**
  - Deceleration time 1 **P221.00**
  - Analog input 1: Min frequency value **P430.02**
  - Analog input 1: Max frequency value **P430.03**
- Press  and hold the key for longer than 3 seconds to save the settings.

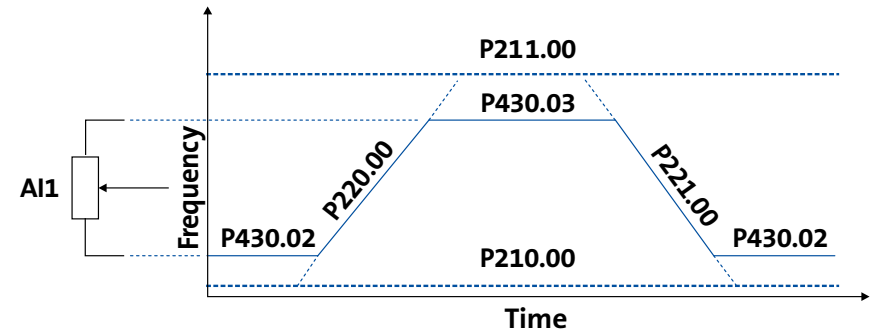



With the wiring shown below, the inverter can be operated using the control terminals (X3).

- Preset 1 is activated if DI4 = HIGH.
- Preset 2 is activated if DI5 = HIGH.
- Preset 3 is activated if DI4 and DI5 = HIGH.

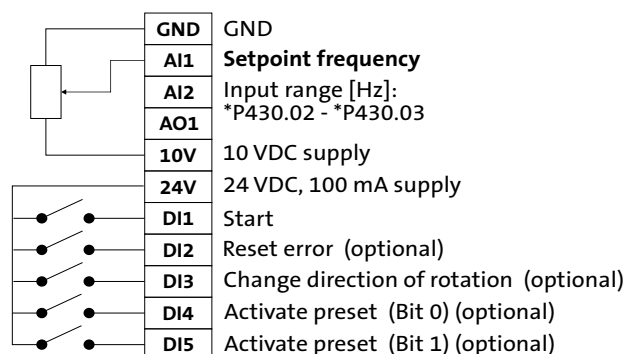

### 7.1.4 Extended terminal control

The following illustration shows a more extensive wiring of the control terminals (X3) linked with the respective parameters.

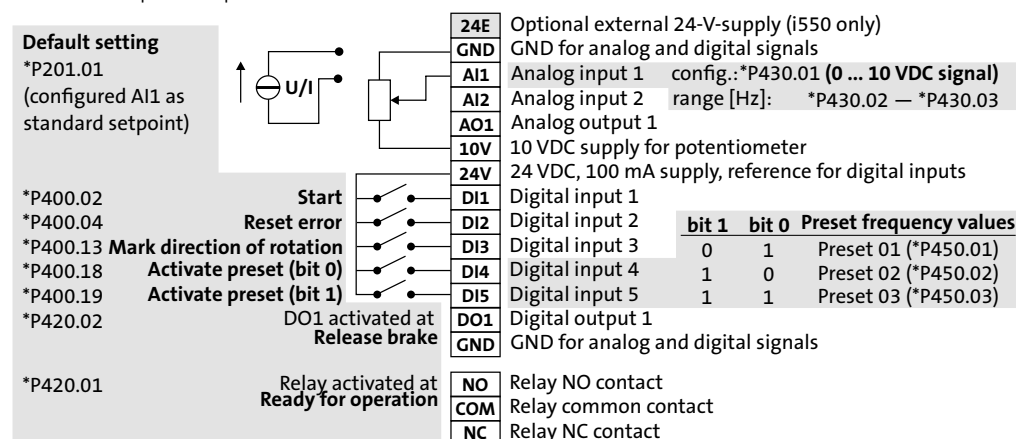

## 7.2 Keypad control

### Activate temporary keypad control

1. Press the key to activate keypad control.
2. Press key for confirming keypad control.

### Deactivate temporary keypad control

1. Press the key to activate keypad control.
2. Press key for confirming keypad control.

### Activate permanent keypad control

If the keypad does not have any keys, motor control is activated via the following parameters:

- ▶ Set parameter **P200.00** to 1.
- ▶ Set parameter **P201.01** to 1.
- ▶ Set parameter **P400.01** to 1.
- ▶ Set parameter **P400.02** to 1.

Then use the key to start the motor.

### Start/control/stop motor with keypad

1. Press the key to start the motor.
  - The keypad shows the motor speed.
2. Change the frequency setpoint using the key or the key.
3. Press the key to stop the motor.

### Change rotating direction

1. Press the key.
2. Press the key to confirm the reversal of rotating direction.

## 7.3 Commissioning with the EASY Starter

Commissioning and diagnostics can be carried out with the EASY starter engineering tool. This requires a USB module and a standard USB cable (A plug to Micro-B plug). <http://www.Lenze.com>

## 7.4 The most important parameters at a glance

This chapter contains the most important parameters and selections. You can find a detailed description in the commissioning document. <http://www.Lenze.com>

The parameters are divided into the following function groups:

- Pxxx.xx group 0: Favorites
- P1xx.xx group 1: Diagnostics
- P2xx.xx group 2: Basic setting
- P3xx.xx group 3: Motor control
- P4xx.xx group 4: I/O setting
- P5xx.xx group 5: Network setting
- P6xx.xx group 6: Process controller
- P7xx.xx group 7: Additional functions
- P8xx.xx group 8: Sequencer

### 7.4.1 Group 0: Favorites

Group 0 contains the configurable favorites that are also contained in the groups 1 to 4. In the default setting these are the most common parameters for the solution of typical applications.

Display code	Name	Possible settings/ value ranges	Keypad code	Information
P100.00	Output frequency	x.x Hz (read only)		Display of the actual output frequency.
P103.00	Current actual	x.x % (read only)		Display of the actual motor current.
P106.00	Motor voltage	x VAC (read only)		Display of the actual motor voltage.
P150.00	Error code	- (read only)		Error message.
P200.00	Control selection	Flexible I/O	[0]	This selection enables a flexible assignment of the start, stop, and rotating direction commands with digital signal sources.
		Keypad	[1]	This selection enables the motor to start exclusively via the start key of the keypad. Other signal sources for starting the motor are ignored.
P201.01	F-setp.source	Keypad	[1]	The setpoint is specified locally by the keypad.
		Analog input 1	[2]	The setpoint is defined as analog signal via the analog input 1.
		Analog input 2	[3]	The setpoint is defined as analog signal via the analog input 2.
		HTL input	[4]	The digital inputs DI3 and DI4 can be configured as HTL input to use an HTL encoder as setpoint encoder or define the setpoint as a reference frequency ("pulse train").
		Network	[5]	The setpoint is defined as process data object via the network.
		Frequency preset 1 ... 15	[11] ... [25]	For the setpoint selection, "preset" values can be parameterized and selected. All frequency presets are described in detail in the commissioning manual. Lenze Doc Finder
P203.01	Start method	Normal	[0]	After start command, the standard ramps are active.
		DC braking	[1]	After start command, the "DC braking" function is active for the time set in P704.02.
		Flying restart circuit	[2]	After the start command, the flying restart circuit is active.
		Premagnetization	[3]	After start command, the standard ramps are active and the premagnetization of the motor is activated. This reduces the motor current and smooths the acceleration curve during the starting process (only relevant in V/f motor control mode).

Default setting = bold print | \* Default setting is device-dependent

Display code	Name	Possible settings/ value ranges	Keypad code	Information
P203.03	Stop method	Coasting	[0]	The motor has no torque (coasts down to standstill).
		<b>Standard ramp</b>	[1]	The motor is brought to a standstill with the deceleration time 1 <b>P221.00</b> (or deceleration time 2 <b>P223.00</b> if activated).
		Quick stop ramp	[2]	The motor is brought to a standstill over the deceleration time set for the "Quick stop" <b>P225.00</b> function.
		Switch-off positioning	[3]	Is similar to the stop method "standard ramp [1]". Depending on the actual output frequency, however, the inverter delays the beginning of the down-ramping so that the number of motor revolutions until standstill is reached and thus the stopping position is always relatively constant.
P208.01	Mains voltage	230 Veff	[0]	Selection of the mains voltage for actuating the inverter.
		400 Veff	[1]	
		480 Veff	[2]	
		120 Veff	[3]	
P210.00	Min. Frequency	<b>0.0 ... 599.0 Hz</b>		Lower limit value for all frequency setpoints.
P211.00	Max. frequency	Device for 50-Hz mains: 50 Hz * Device for 60-Hz mains: 60 Hz *		Upper limit value for all frequency setpoints.
P220.00	Acceleration 1	0.0 ... <b>5.0</b> ... 3600.0 s		Acceleration time 1.
P221.00	Deceleration 1	0.0 ... <b>5.0</b> ... 3600.0 s		Deceleration time 1
P300.00	Motor ctrl mode	Servo control (SC ASM)	[2]	This control mode is used for servo control of an asynchronous motor. This motor control mode is described in the commissioning manual. Lenze Doc Finder
		Sensorless control (SL PSM)	[3]	This control type is used for the sensorless control of a synchronous motor. This motor control mode is described in the commissioning manual. Lenze Doc Finder
		Sensorless vector control (SLVC)	[4]	This control type is used for sensorless vector control of an asynchronous motor. Observe parameters <b>P327.04</b> and <b>P327.05</b> for this purpose.
		<b>V/f characteristic control (VFC open loop)</b>	[6]	This control mode is used for the speed control of an asynchronous motor via a V/f characteristic and is the simplest control mode.
P302.00	V/f characteristic shape	<b>Linear</b>	[0]	Linear characteristic for drives with constant load torque over the speed.
		Square-law	[1]	Square-law characteristic for drives with a square-law load torque over the speed.
		Eco	[3]	Linear characteristic with energy optimization in the partial load operational range.
P303.01	Base voltage	0 ... <b>230</b> ... 5000 V *		Base voltage and base frequency define the V/f ratio and thus the gradient of the V/f characteristic. <ul style="list-style-type: none"> <li>The V/f base voltage is usually set to the rated motor voltage.</li> <li>The V/f base frequency is usually set to the rated motor frequency.</li> </ul>
P303.02	Base frequency	Device for 50-Hz mains: 50 Hz * Device for 60-Hz mains: 60 Hz *		Base voltage and base frequency define the V/f ratio and thus the gradient of the V/f characteristic. <ul style="list-style-type: none"> <li>The V/f base voltage is usually set to the rated motor voltage.</li> <li>The V/f base frequency is usually set to the rated motor frequency.</li> </ul>
P304.00	Limitation of rotation	Only clockwise (CW)	[0]	The motor can only be rotated clockwise (CW). The transfer of negative frequency and PID setpoints to the motor control is prevented.
		<b>Both rotation directions</b>	[1]	Both directions of motor rotation are enabled.
P305.00	Switching frequency	8 kHz var/opt/4 *		Selection of the inverter switching frequency.
P306.01	Overload selection	Heavy duty	[0]	Load characteristic for high dynamic requirements.
		Light Duty	[1]	Load characteristic for low dynamic requirements.
P308.01	Max. load for 60s	30 ... <b>150</b> ... 200 %		Maximum permissible thermal motor utilization (max. permissible motor current for 60 seconds). With regard to rated motor current ( <b>P323.00</b> ).
P316.01	Fixed V/f boost	0.0 ... <b>2.5</b> ... 20.0 % *		Constant voltage boost for the V/f characteristic control without feedback.
<b>Default setting = bold print   * Default setting is device-dependent</b>				

Display code	Name	Possible settings/ value ranges	Keypad code	Information
P323.00	Motor current	0.001 ... <b>1.700</b> ... 500.000 A *		Setting of the rated motor current according to motor nameplate.
P324.00	Max current	0.0 ... <b>200.0</b> ... 3000.0 %		Maximum overload current of the inverter.
P400.01	Inverter enable	TRUE	[1]	Assignment of a trigger to the “inverter enable” function. Trigger = TRUE: The inverter is enabled (unless there is another cause for inverter disable). Trigger = FALSE: The inverter is disabled. The motor has no torque and coasts.
P400.02	Run	Digital input 1	[11]	Assignment of a trigger to the “Run” function.  <b>Function 1: Start/stop motor (default setting)</b> Function 1 is active if no further start commands (start forward/start reverse) have been connected to triggers, no keypad control is active and no network control is active. Trigger = TRUE: Let motor rotate forward (CW). Trigger = FALSE: Stop motor according to stop function ( <b>P203.03</b> ).  <b>Function 2: Start clearance/stop motor</b> Function 2 is active if further start commands have been connected to triggers, the keypad control is active or the network control is active. Trigger = TRUE: Start commands of the active control source are enabled. Trigger = FALSE: Stop motor.
P400.03	Quick stop	Not connected	[0]	Assignment of a trigger to the “Activate quick stop” function. Trigger = TRUE: Activate quick stop. Quick stop ramp <b>P225.00</b> . Trigger = FALSE: Deactivate quick stop
P400.04	Error reset	Digital input 2	[12]	Assignment of a trigger to the “Reset error” function. Trigger = FALSE > TRUE (edge): The active error is reset (acknowledged) if the error condition is no longer active and the error is resettable. Trigger = FALSE: No action.
P400.05	DC braking	Not connected	[0]	Assignment of a trigger to the “Activate DC braking” function. Trigger = TRUE: Activate DC braking. Trigger = FALSE: Deactivate DC braking.
P400.06	Start forward	Not connected	[0]	Assignment of a trigger to the “Start forward (CW)” function. Trigger = FALSE > TRUE (edge): Let motor rotate forward. Trigger = TRUE > FALSE (edge): No action. Stop via <b>P400.01</b> (default setting of digital input 1).
P400.07	Start reverse	Not connected	[0]	Assignment of a trigger to the “Start reverse (CCW)” function. Trigger = FALSE > TRUE (edge): Let motor rotate backward. Trigger = TRUE > FALSE (edge): No action. Stop via <b>P400.01</b> (default setting of digital input 1).
P400.08	Run forward	Not connected	[0]	Assignment of a trigger to the “Run forward (CW)” function. Trigger = TRUE: Let motor rotate forward. Trigger = FALSE: Stop motor. Stop via <b>P400.01</b> (default setting of digital input 1).
P400.09	Run reverse	Not connected	[0]	Assignment of a trigger to the “Run reverse (CCW)” function. Trigger = TRUE: Let motor rotate backward. Trigger = FALSE: Stop motor. Stop via <b>P400.01</b> (default setting of digital input 1).
P400.13	Reverse rot. dir.	Digital input 3	[13]	Assignment of a trigger to the “Reverse rotating direction” function. Trigger = TRUE: The setpoint specified is inverted (i.e. the sign is inverted). Trigger = FALSE: No action / deactivate function again.

Default setting = bold print | \* Default setting is device-dependent

Display code	Name	Possible settings/ value ranges	Keypad code	Information
P400.18	Setp: Preset B0	Digital input 4	[14]	Assignment of a trigger to the "Activate preset (bit 0)" function. Bit with the value 20 for the bit-coded selection and activation of a configured setpoint (preset value). Trigger = FALSE: Bit = "0". Trigger = TRUE: Bit = "1".
P400.19	Setp: Preset B1	Digital input 5	[15]	Assignment of a trigger to the "Activate preset (bit 1)" function. Bit with the value 21 for the bit-coded selection and activation of a configured setpoint (preset value). Trigger = FALSE: Bit = "0". Trigger = TRUE: Bit = "1".
P400.20	Setp: Preset B2	Not connected	[0]	Assignment of a trigger to the "Activate preset (bit 2)" function. Bit with the value 22 for the bit-coded selection and activation of a configured setpoint (preset value). Trigger = FALSE: Bit = "0". Trigger = TRUE: Bit = "1".
P420.01	Relay function	Running	[50]	TRUE if inverter and start are enabled and output frequency > 0.2 Hz. Otherwise FALSE.
		<b>Ready for operation</b>	[51]	TRUE if inverter is ready for operation (no error active, no STO active and DC-bus voltage ok). Otherwise FALSE.
		Operation enabled	[52]	TRUE if inverter and start are enabled. Otherwise FALSE.
		Stop active	[53]	TRUE if inverter is enabled and motor is not started and output frequency = 0.
		Error active	[56]	TRUE if error is active. Otherwise FALSE.
		Device warning active	[58]	TRUE if warning is active. Otherwise FALSE.
P420.02	DO1 function	Release brake	[115]	Assignment of a trigger to digital output 1. Trigger = FALSE: X3/DO1 set to LOW level. Trigger = TRUE: X3/DO1 set to HIGH level.
P430.01	AI1 input area	<b>0 ... 10 VDC</b>	[0]	Definition of the input range.
		0 ... 5 VDC	[1]	
		2 ... 10 VDC	[2]	
		-10 ... +10 VDC	[3]	
		4 ... 20 mA	[4]	
		0 ... 20 mA	[5]	
P430.02	AI1 freq @ min	- 1000.0 ... <b>0.0</b> ... 1000.0 Hz		Definition of the setting range for AI1. <ul style="list-style-type: none"> <li>Direction of rotation according to sign.</li> <li>Standard setpoint source for operating mode is selected in <b>P201.01</b>.</li> </ul>
P430.03	AI1 freq @ max	50.0 Hz *   60.0 Hz *		Definition of the setting range for operating mode "MS: Velocity mode". <ul style="list-style-type: none"> <li>Direction of rotation according to sign.</li> <li>Standard setpoint source for operating mode is selected in <b>P201.01</b>.</li> </ul>
P440.01	AO1 output area	Disabled	[0]	Definition of the output range.
		<b>0 ... 10 VDC</b>	[1]	
		0 ... 5 VDC	[2]	
		2 ... 10 VDC	[3]	
		4 ... 20 mA	[4]	
		0 ... 20 mA	[5]	

Default setting = bold print | \* Default setting is device-dependent

Display code	Name	Possible settings/ value ranges	Keypad code	Information
P440.02	AO1 function	<b>Output frequency</b>	[1]	Actual output frequency (resolution: 0.1 Hz).
		Frequency setpoint	[2]	Actual frequency setpoint (resolution: 0.1 Hz).
		Analog input 1	[3]	Input signal from analog input 1 (resolution: 0.1 %).
P440.03	AO1 min. Signal	-2147483648 ... <b>0</b> ... 2147483647		Definition of the signal value that corresponds to the minimum value at analog output 1.
P440.04	AO1 max. signal	-2147483648 ... <b>1000</b> ... 2147483647		Definition of the signal value that corresponds to the maximum value at analog output 1.
P450.01	Freq. preset 1	0.0 ... <b>20.0</b> ... 599.0 Hz		Parameterizable frequency setpoints (preset 1).
P450.02	Freq. preset 2	0.0 ... <b>40.0</b> ... 599.0 Hz		Parameterizable frequency setpoints (preset 2).
P450.03	Freq. preset 3	0.0 ... <b>50.0   60.0</b> ... 599.0 Hz *		Parameterizable frequency setpoints (preset 3).
P450.04	Freq. preset 4	0.0 ... <b>0.0</b> ... 599.0 Hz		Parameterizable frequency setpoints (preset 4).
<b>Default setting = bold print   * Default setting is device-dependent</b>				

## 7.4.2 Group 2: Basic setting

Display code	Name	Possible settings	Keypad code	Information
P225.00	Quick stop deceleration time	1.0 s		<p>Quick stop deceleration time for “MS: Velocity mode”</p> <ul style="list-style-type: none"> <li>If the “Quick stop” function is activated, the motor is brought to a standstill within the deceleration time set here.</li> <li>The set deceleration time refers to the period of deceleration from the set maximum frequency (<b>P211.00</b>) to standstill. In the case of a lower actual frequency, the actual deceleration time is reduced accordingly.</li> <li>Setting is not effective in operating mode <b>P301.00</b> = “CiA:Velocity mode”.</li> </ul>

## 7.4.3 Group 3: Motor control

Display code	Name	Possible settings	Keypad code	Information
P320.04	Rated torque	50 ... 50000 rpm		General motor data.
P320.05	Rated frequency	1.0 ... 1000.0 Hz		Configure settings as specified by the data on the motor nameplate.
P320.06	Rated power	0.00 ... 655.35 kW		<p>Note!</p> <p>Take the phase connection implemented for the motor (star or delta configuration) into account when entering the motor nameplate data. Only enter data associated with the relevant configuration.</p>
P320.07	Rated voltage	0 ... 65535 V		
P320.08	Cosine phi	0.00 ... 1.00		
P327.04	Identify motor data	0 ... 1		<p>1 = start automatic identification of the motor data.</p> <ul style="list-style-type: none"> <li>Inverter characteristics, motor equivalent circuit data and controller settings are identified and set automatically.</li> <li>The motor is energized during the procedure!</li> </ul>
P327.05	Calibrate motor data (non-energized)	0 ... 1		<p>1 = start automatic calibration of the motor data.</p> <ul style="list-style-type: none"> <li>A default inverter characteristic is loaded.</li> <li>The motor equivalent circuit data and controller settings are calculated on the basis of the currently set rated motor data.</li> <li>The motor is not energized.</li> </ul>

#### 7.4.4 Group 7: Additional functions

Display code	Name	Possible settings	Keypad code	Information
P700.01	Device commands: Load default settings	<b>Off / ready</b>	[0]	Only status feedback
		On / start	[1]	1 = reset all parameters in the RAM memory of the inverter to the default setting that is stored in the inverter firmware. <ul style="list-style-type: none"> <li>All parameter changes made by the user are lost during this process!</li> <li>This process may take some seconds. When the device command has been executed successfully, the value 0 is shown.</li> <li>Loading parameters has a direct effect on cyclic communication: The data exchange for control is interrupted and a communication error is generated.</li> </ul>
P700.03	Device commands: Save user data	<b>Off / ready</b>	[0]	Only status feedback
		On / start	[1]	Execute device commands
		In progress	[2]	Only status feedback
		Action cancelled	[3]	
		No access	[4]	
		No access (inverter disabled)	[5]	

## 8 Troubleshooting

### 8.1 Error message

If an error is pending, the keypad shows the following information.

<p>The keypad display shows 'Warn. DC Bus UV' in the top line and 'W3221' in the bottom line. Below the display are three keys: 'REM', 'AUTO', and 'SET'. Circled numbers 1, 2, and 3 point to the error text, error type, and error code respectively.</p>	1 = error text	
	2 = error type	F = fault
		T = trouble
		W = warning
3 = error code (hexadecimal)		
Faults (F) and trouble (T) are displayed continuously. The inverter is disabled.		
Warnings (W) are displayed every 2 seconds for a short time. The inverter is probably disabled.		

### 8.2 Reset error

#### Reset error via keypad

Errors can be reset using the key if the cause of the error has been eliminated and no blocking time is active.

- ▶ Press the key to reset the error. The motor is stopped.
- ▶ Press the key to revoke the stop.

#### Reset error via terminal control

When terminal control is used, errors can be reset in 2 ways:

1. Via start signal **P400.02** (default setting of digital input 1).
  - Cause of error has been eliminated and no blocking time is active.
  - The signal at the digital input 1 (**P400.02**) must drop and then be applied again.
2. Via **P400.04** (default setting of digital input 2).
  - Cause of error has been eliminated and no blocking time is active.
  - The error is reset if a signal is applied to digital input 2 (**P400.04**).













### 8.3 Error codes

Error code	Description	Classification	Remedy	Blocking time [s]	Reset possible
2250	CiA: Continuous overcurrent (inside the device)	Error	<ul style="list-style-type: none"> <li>• Check motor and wiring for short circuits.</li> <li>• Check brake resistor and wiring.</li> <li>• Check motor switching.</li> <li>• Check motor data settings.</li> </ul>	5	Yes
2320	Short circuit or earth leakage on the motor side	Error	<ul style="list-style-type: none"> <li>• Check motor cable.</li> <li>• Check length of motor cable.</li> <li>• Use shorter or lower-capacitance motor cable.</li> </ul>	5	Yes
2340	CiA: Short circuit (inside the device)	Error	<ul style="list-style-type: none"> <li>• Check motor cable for short circuit.</li> </ul>	5	Yes
2350	CiA: $i^2 \cdot t$ overload (thermal state)	Error	<ul style="list-style-type: none"> <li>• Check drive dimensions.</li> <li>• Check machine/driven mechanics for excessive load.</li> <li>• Check motor data settings.</li> <li>• Reduce values for slip compensation (<b>P315.01</b>, <b>P315.02</b>) and oscillation damping (<b>P318.01</b>, <b>P318.02</b>).</li> </ul>	5	Yes
2382	Error: Device utilisation (Ixt) too high	Error	<ul style="list-style-type: none"> <li>• Check drive dimensions.</li> <li>• Reduce maximum overload current of the inverter (<b>P324.00</b>).</li> <li>• In case of high mass inertias, reduce maximum overload current of the inverter (<b>P324.00</b>) to 150 %.</li> </ul>	3	Yes
2383	Warning: Device utilisation (Ixt) too high	Warning	<ul style="list-style-type: none"> <li>• Check drive dimensions.</li> </ul>	0	Yes
3120	Mains phase fault	Error	<ul style="list-style-type: none"> <li>• Check mains connection wiring.</li> <li>• Check fuses.</li> </ul>	0	Yes
3210	DC bus overvoltage	Error	<ul style="list-style-type: none"> <li>• Reduce dynamic performance of the load profile.</li> <li>• Check mains voltage.</li> <li>• Check settings for brake energy management.</li> <li>• Connect brake resistor to the power unit and activate the integrated brake chopper. (<b>P706.01</b> = 0: brake resistance).</li> </ul>	0	Yes
3211	Warning: DC bus overvoltage	Warning	<ul style="list-style-type: none"> <li>• Reduce dynamic performance of the load profile.</li> <li>• Check mains voltage.</li> <li>• Check settings for brake energy management.</li> <li>• Connect brake resistor to the power unit and activate the integrated brake chopper. (<b>P706.01</b> = 0: brake resistance).</li> </ul>	0	Yes
3220	DC bus undervoltage	Trouble	<ul style="list-style-type: none"> <li>• Check mains voltage.</li> <li>• Check fuses.</li> <li>• Check DC-bus voltage (<b>P105.00</b>).</li> <li>• Check mains settings.</li> </ul>	0	Yes
3221	Warning: DC bus undervoltage	Warning	<ul style="list-style-type: none"> <li>• Check mains voltage.</li> <li>• Check fuses.</li> <li>• Check DC bus voltage.</li> <li>• Check mains settings.</li> </ul>	0	Yes
3222	DC-bus voltage too low for switch-on	Warning	<ul style="list-style-type: none"> <li>• Check mains voltage.</li> <li>• Check fuses.</li> <li>• Check mains settings.</li> </ul>	0	Yes

Error code	Description	Classification	Remedy	Blocking time [s]	Reset possible
4210	PU: Overtemperature fault	Error	<ul style="list-style-type: none"> <li>Check mains voltage.</li> <li>Ensure sufficient cooling of the device (heatsink temperature displayed in <b>P117.01</b>).</li> <li>Clean fan and ventilation slots. Replace fan if necessary.</li> <li>Reduce switching frequency (<b>P305.00</b>).</li> </ul>	0	Yes
4281	Heatsink fan warning	Warning	<ul style="list-style-type: none"> <li>Clean fan and ventilation slots. If required, replace fan. The fans can be unlocked via locking hooks and can then be removed.</li> </ul>	0	Yes
4310	Error: Motor overtemperature	Error	<ul style="list-style-type: none"> <li>Check drive dimensions.</li> </ul>	5	Yes
6280	Trigger/functions connected incorrectly	Trouble	<p>Check and correct the assignment of the triggers to the functions.</p> <ul style="list-style-type: none"> <li>When keypad or network control is active, the two functions "Inverter enable" (<b>P400.01</b>) and "Run" (<b>P400.02</b>) can also be set to "Constant TRUE [1]" to start the motor.</li> </ul>	0	Yes
7180	Motor overcurrent	Error	<ul style="list-style-type: none"> <li>Check motor load.</li> <li>Check drive dimensions.</li> <li>Adapt set warning threshold or error threshold to <b>P353.01</b>.</li> </ul>	1	Yes
9080	Keypad removed	Error	<ul style="list-style-type: none"> <li>Plug in the keypad again or activate another control source.</li> </ul>	0	Yes
FF06	Motor overspeed	Error	<ul style="list-style-type: none"> <li>Adapt the maximum motor speed (<b>P322.00</b>) and the warning threshold or error threshold (<b>P350.01</b>).</li> </ul>	1	Yes
FF37	Automatic start disabled	Error	<ul style="list-style-type: none"> <li>Deactivate start command and reset error.</li> </ul>	0	Yes
FF85	Keypad full control active	Warning	<ul style="list-style-type: none"> <li>Press the keypad key  to exit control mode.</li> </ul>	0	Yes

## 8.4 LED status

LED "RDY" (blue)	LED "ERR" (red)	Status/meaning
off	off	No supply voltage.
		Mains voltage is switched on, inverter is initialized.
 flashes	off	Inverter is disabled, ready for operation.
	 flashes fast	Safe torque off (STO) active, warning active.
 flashes	off	Inverter disabled.
	 flashes fast	Inverter disabled, warning active.
		Inverter disabled, error active.
	 every 1.5 s on	Inverter disabled, no DC-bus voltage.
	off	Inverter enabled.
	off	The motor rotates according to the specified setpoint or quick stop active.
	 flashes fast	Inverter enabled, warning active. The motor rotates according to the specified setpoint or active "Quick stop" function.
	 flashes	Inverter enabled, quick stop as response to fault active.

## 9 Further documents

For certain tasks, information is available in further documents.

Document	Contents/topics
Project planning document	Fundamental information on project planning and ordering the product
Commissioning document	Fundamental information for the installation and commissioning of the product
Mounting instructions	Fundamental information on mounting the product

The documents can be found in the [Lenze Doc Finder](#).

## 10 Disposal

If pollutants are disposed off improperly, they may cause a lasting damage to human health and the environment. Thus, electrical and electronic equipment must be collected separately from unsorted municipal waste so that it may be recycled or disposed of properly.

If available, put the components to the company internal disposal from where it is passed on to specialized waste management companies.

It is also possible to return the components to the manufacturer. For this purpose, please contact the customer service of the manufacturer.

More detailed information on disposal can be obtained from the corresponding specialist firms and the competent authorities.

The packaging of the component must be disposed of separately. Paper, cardboard and plastics must be recycled.

## 11 Glossary

Abbreviation	Meaning
AIE	Error acknowledgement ("Acknowledge In Error")
OFF state	Signal status of the safety sensor when it triggers or responds
QSP	Quick stop

---

© 01/2020 | 2.0

Lenze Drives GmbH  
P.O. box 10 13 52, 31763 Hameln  
Breslauer Strasse 3, 32699 Extertal  
GERMANY  
HR Lemgo B 6478  
Tel.: +49 5154 82-0  
Fax: +49 5154 82-2800  
Email: [Sales.de@Lenze.com](mailto:Sales.de@Lenze.com)  
Web: [www.Lenze.com](http://www.Lenze.com)

Lenze Service GmbH  
Breslauer Strasse 3, 32699 Extertal  
GERMANY  
Tel.: 0080002446877 (24-h helpline)  
Fax: +49 5154 82-1112  
Email: [Service.de@Lenze.com](mailto:Service.de@Lenze.com)

**Lenze**